



AFRL-RX-TY-TR-2008-4616

PRECAST/PRESTRESSED CONCRETE EXPERIMENTS – SERIES 1 (VOLUME I)

Clay J. Naito
Associate Professor
Department of Civil and Environmental Engineering
Lehigh University, PA 18015

Robert J. Dinan
Air Force Research Laboratory
139 Barnes Drive, Suite 2
Tyndall AFB, FL 32403-5323

Jeff W. Fisher and John M. Hoemann
Applied Research Associates
P.O. Box 40128
Tyndall AFB, FL 32403

NOVEMBER 2008

Interim Report for 11 July 2006 – 19 October 2007

**DISTRIBUTION STATEMENT A: Approved for public release;
distribution unlimited.**

The use of the name or mark of any specific manufacturer, commercial product, commodity, or service in this publication does not imply endorsement by the Air Force.

**AIRBASE TECHNOLOGIES DIVISION
MATERIALS AND MANUFACTURING DIRECTORATE
AIR FORCE RESEARCH LABORATORY
AIR FORCE MATERIEL COMMAND
139 BARNES DRIVE, SUITE 2
TYNDALL AIR FORCE BASE, FL 32403-5323**

NOTICE AND SIGNATURE PAGE

Using Government drawings, specifications, or other data included in this document for any purpose other than Government procurement, does not in any way obligate the U.S. Government. The fact that the Government formulated or supplied the drawings, specifications, or other data does not license the holder or any other person or corporation; or convey any rights or permission to manufacture, use, or sell any patented invention that may relate to them.

Qualified requestors may obtain copies of this report from the Defense Technical Information Center (DTIC) (<http://www.dtic.mil>).

REPORT NUMBER AFRL-RX-TY-TR-2008-4616 HAS BEEN REVIEWED AND APPROVED FOR PUBLICATION IN ACCORDANCE WITH THE ASSIGNED DISTRIBUTION STATEMENT.



ROBERT J. DINAN, PhD
Program Manager

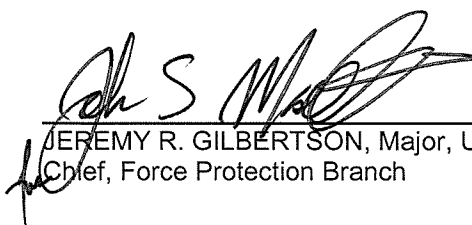

JEREMY R. GILBERTSON, Major, USAF
Chief, Force Protection Branch



ALBERT N. RHODES, PhD
Acting Chief, Airbase Technologies Division

This report is published in the interest of scientific and technical information exchange, and its publication does not constitute the Government's approval or disapproval of its ideas or findings.

REPORT DOCUMENTATION PAGE

*Form Approved
OMB No. 0704-0188*

The public reporting burden for this collection of information is estimated to average 1 hour per response, including the time for reviewing instructions, searching existing data sources, gathering and maintaining the data needed, and completing and reviewing the collection of information. Send comments regarding this burden estimate or any other aspect of this collection of information, including suggestions for reducing the burden, to Department of Defense, Washington Headquarters Services, Directorate for Information Operations and Reports (0704-0188), 1215 Jefferson Davis Highway, Suite 1204, Arlington, VA 22202-4302. Respondents should be aware that notwithstanding any other provision of law, no person shall be subject to any penalty for failing to comply with a collection of information if it does not display a currently valid OMB control number.

PLEASE DO NOT RETURN YOUR FORM TO THE ABOVE ADDRESS.

1. REPORT DATE (DD-MM-YYYY) 17-NOV-2008	2. REPORT TYPE Final Technical Report	3. DATES COVERED (From - To) 11-JUL-2006 -- 19-OCT-2007
---	---	---

4. TITLE AND SUBTITLE Precast/Prestressed Concrete Experiments -- Series 1 (Volume I)	5a. CONTRACT NUMBER CRADA 05-119-ML-01
	5b. GRANT NUMBER
	5c. PROGRAM ELEMENT NUMBER 62102F

6. AUTHOR(S) Naito, Clay J.; **Dinan, Robert J.; *Fisher, Jeff W.; *Hoemann, John M.	5d. PROJECT NUMBER 4915
	5e. TASK NUMBER F2
	5f. WORK UNIT NUMBER Q210FA72

7. PERFORMING ORGANIZATION NAME(S) AND ADDRESS(ES) Department of Civil and Environmental engineering, Lehigh University, PA 18015 *Applied Research Associates, P.O. Box 40128, Tyndall Air Force Base, FL 32403	8. PERFORMING ORGANIZATION REPORT NUMBER
---	---

9. SPONSORING/MONITORING AGENCY NAME(S) AND ADDRESS(ES) **Air Force Research Laboratory Materials and Manufacturing Directorate Airbase Technologies Division 139 Barnes Drive, Suite 2 Tyndall Air Force Base, FL 32403-5323	10. SPONSOR/MONITOR'S ACRONYM(S) AFRL/RXQF
	11. SPONSOR/MONITOR'S REPORT NUMBER(S) AFRL-RX-TY-TR-2008-4616

12. DISTRIBUTION/AVAILABILITY STATEMENT
Distribution Statement A: Approved for public release; distribution unlimited.

13. SUPPLEMENTARY NOTES
Ref AFRL/RXQ Public Affairs Case # 09-072. Document contains color images.

14. ABSTRACT
Protection against blast generated pressure loads has become a high priority for many building owners. Blast retrofits and structural hardening, much like earthquake retrofits, can prove to be costly. For this reason, it is important to understand that any structural element has an inherent capacity to absorb energy and resist some level of blast pressure. A general evaluation that allows a designer to realize the absorption capacity of a structural element may preclude the need for a blast-specific retrofit. To illustrate this concept, the blast resistances of non-load bearing precast, prestressed concrete sandwich wall panels (WP) are examined. These components are used extensively in modern construction for cladding of building systems and often provide a significant level of protection from blast events.

15. SUBJECT TERMS
concrete wall panels, impulsive load, air-blast, sandwich wall

16. SECURITY CLASSIFICATION OF:			17. LIMITATION OF ABSTRACT UU	18. NUMBER OF PAGES 38	19a. NAME OF RESPONSIBLE PERSON Robert J. Dinan
a. REPORT U	b. ABSTRACT U	c. THIS PAGE U			19b. TELEPHONE NUMBER (Include area code)

Reset

TABLE OF CONTENTS

1. Introduction	1
2. Objectives	2
3. Panel Construction	3
3.1. Solid Zone Wall Panel.....	5
3.2. CFRP Wall Panel.....	5
3.3. Control Wall Panel.....	6
3.4. Material Properties.....	6
4. Experimental Setup	7
4.1. Instrumentation.....	7
4.1.1 Displacement and Pressure	8
4.1.2 Video.....	8
5. Blast Demands	10
5.1. Experiment 1 – Control 1 vs. Solid Zone 1	10
5.2. Experiment 2 – Control 1 vs. Solid Zone 1	12
5.3. Experiment 3 – Control 2 vs. CFRP 1	16
5.4. Experiment 4 – Control 2 vs. CFRP 1	19
5.5. Experiment 5 – Control 2 vs. CFRP 1	21
6. SBEDS Comparison	28
7. Summary	31

LIST OF FIGURES

Figure 1: Wall Elevations.....	4
Figure 2: Wall Sections.....	4
Figure 3: C-grid® wythe connection after testing (note section is damaged in photo due to loading) 5	5
Figure 4: Loading configuration	7
Figure 5: Instrumentation layout	8
Figure 6: Reaction structure prior to detonation.....	9
Figure 7: Measured reflected pressure demands for each experiment.....	10
Figure 8: Measured reflected pressure and deflections for Experiment 1 Solid Zone Panel	11
Figure 9: Measured reflected pressure and deflections for Experiment 1 Control Panel.....	12
Figure 10: Measured reflected pressure and deflections for Experiment 2 Solid Zone Panel 1	13
Figure 11: Measured reflected pressure and deformation response of Experiment 2 Control Panel 1	14
Figure 12: Post test condition of panels.....	14
Figure 13: Flexural crack location on control panel and side of panel	15
Figure 14: Flexural crack locations on solid zone panel.....	16
Figure 15: Measured reflected pressure and deflections for Experiment 3 CFRP Panel 1.....	18
Figure 16: Measured reflected pressure and deflections for Experiment 3 Control Panel 2.....	18
Figure 17: Measured cracking on inside face of panels post-test 3	19
Figure 18: Measured reflected pressure and deflections for Experiment 4 CFRP Panel 1.....	20
Figure 19: Measured reflected pressure and deflections for Experiment 4 Control Panel 2.....	21
Figure 20: Measured reflected pressure and deflections for Experiment 5 CFRP Panel 1.....	23
Figure 21: Measured reflected pressure and deflections for Experiment 5 Control Panel 2.....	23
Figure 22: CFRP wall deformed shape before, during and after Experiment 5.....	24
Figure 23: Control wall deformed shape before, during and after Experiment 5	25
Figure 24: External View of Panels after Experiment 5	26
Figure 25: Internal View of Control Panel after Experiment 5	26
Figure 26: Internal view of CFRP panel after Experiment 5	27
Figure 27: Control wall measured and predicted response.....	29
Figure 28: Solid zone wall measured and predicted response	29
Figure 29: CFRP wall measured and predicted response.....	30
Figure 30: Peak mid-height deflections for control panels XX	31
Figure 31: Peak mid-height deflections for sandwich panels XX.....	31

LIST OF TABLES

1: Test matrix and applied blast demands	10
2: Max pressure, impulse, and displacements Experiment 1 [psi, psi-ms, in.]	11
3: Max pressure, impulse, and displacements 2 [psi, psi-ms, in.]	13
4: Max pressure, impulse, and displacements Experiment 3 [psi, psi-ms, in.]	17
5: Max pressure, impulse, and displacements Experiment 4 [psi, psi-ms, in.]	20
6: Max pressure, impulse, and displacements Experiment 5 [psi, psi-ms, in.]	22

1. Introduction

Protection against blast generated pressure loads has become a high priority for many building owners. Blast retrofits and structural hardening, much like earthquake retrofits, can prove to be costly. For this reason, it is important to understand that any structural element has an inherent capacity to absorb energy and resist some level of blast pressure. A general evaluation that allows a designer to realize the absorption capacity of a structural element may preclude the need for a blast-specific retrofit. To illustrate this concept, the blast resistances of non-load bearing precast, prestressed concrete sandwich wall panels (WP) are examined. These components are used extensively in modern construction for cladding of building systems and often provide a significant level of protection from blast events.

The information presented in this report represents the first phase of work under Collaborative Research and Development Agreement (CRADA) # 05-119-ML-01, entitled Blast Resistant Concrete Products. The CRADA is between the Portland Cement Association (PCA) and the Air Force Research Laboratory, Airbase Technology Division at Tyndall Air Force Base. Support and donations have also been provided from the Precast/Prestressed Concrete Institute (PCI) and its member companies. The overall research objective is to assess the inherent blast resistance of conventional concrete products.

The overall research program is focused on protection from explosive detonations at moderate standoff distances from the structure. In the first round of research, wall systems are examined for each facet of the Portland Cement Associations' membership. This includes Prestressed/Precast Concrete Wall Panels for the Prestressed / Precast Concrete Institute (PCI), Tilt-up Concrete Wall Panels for the Tilt-up Concrete Association (TCA), Masonry Walls for the National Concrete Masonry Association (NCMA), Cast-in-place walls for the National Concrete Ready Mix Association (NCRMA), and Insulated Concrete Wall Panels for the Insulated Concrete Form Association (ICFA).

For all concrete associations the objectives of the research are to:

- Verify if conventional wall systems are capable of remaining standing after a significant blast event.
- Identify if a wall system is capable of providing enough protection for temporary evaluation and/or continued function after a blast event.

The research presented in this report examines the research objectives as they apply to precast/prestressed concrete wall panels.

2. Objectives

This report investigates the behavior of precast, prestressed concrete wall panels (WPs) subjected to blast loads. The panels are analyzed using single degree of freedom modeling techniques to generate predictive responses. This report summarizes the measured performance of the walls compared to their expected response. Specific objectives are as follows:

- Evaluate the full-scale blast performance of a non-load bearing, precast/prestressed concrete sandwich wall panel with solid zones connecting the interior and exterior wythes. Compare response to a control wall with comparable mass, constructed with only rebar reinforcement, no prestressed tendons.
- Evaluate the full-scale blast performance of a non-load bearing, precast/prestressed concrete sandwich panel carbon fiber reinforced plastic (CFRP) grids (C-Grid®) connecting the interior and exterior wythes. Compare response to a control wall with comparable mass, constructed with only rebar reinforcement, no prestressed tendons.

The panels were subjected to full-scale explosions at the Air Force Research Lab, Tyndall AFB in Florida.

3. Panel Construction

Standard design of wall panels are often governed by the loads required for stripping, shipping and installation. For cases where wind exposure is high, wind demands may control the flexural design of the panels. To ensure that the building envelope meets fire protection and thermal insulation requirements the wall panels are often fabricated with an interior and exterior section or wythe separated by rigid board insulation. Initially conventional design practice considered the interior section as the structural wythe sized to carry all the load demands on the panel. The exterior wythe was considered a purely architectural wythe which contains the appropriate surface finishes. As the construction method matured designers began treating the two wythes as a full or partially composite cross section for flexural strength depending on the exterior-to-interior wythe connection mechanism. Some designers today still ignore any composite action between the two wythes. This sandwich construction method yields panels that have a relatively deep cross section and considerable mass. These properties make the wall ideal for resisting dynamic pressures generated from explosions.

The panels measure 30 ft – 8 in. tall and 8 ft wide. The walls are supported only at the top and bottom, typical of low-rise construction. Due to the support conditions an effective span of 30ft is used. For building systems with shorter floor heights an intermediate support is often used. The research program looks at the case when the intermediate floor has adequate setback to allow the wall panel to behave as simply supported over its height. The 30 ft span simplifies the initial response models, represents the largest anticipated moment demands and provides a large section at mid-span that is fully prestressed without supplemental anchorage for the prestressing tendons. These conditions do not occur often in practical applications but are well suited for initial blast response research.

Three wall panel types were constructed: solid zone sandwich panel, carbon fiber reinforced polymer (CFRP) sandwich panel, and a solid reinforced concrete control panel. The wall elevations are illustrated in Figure 1 and the cross sections in Figure 2.

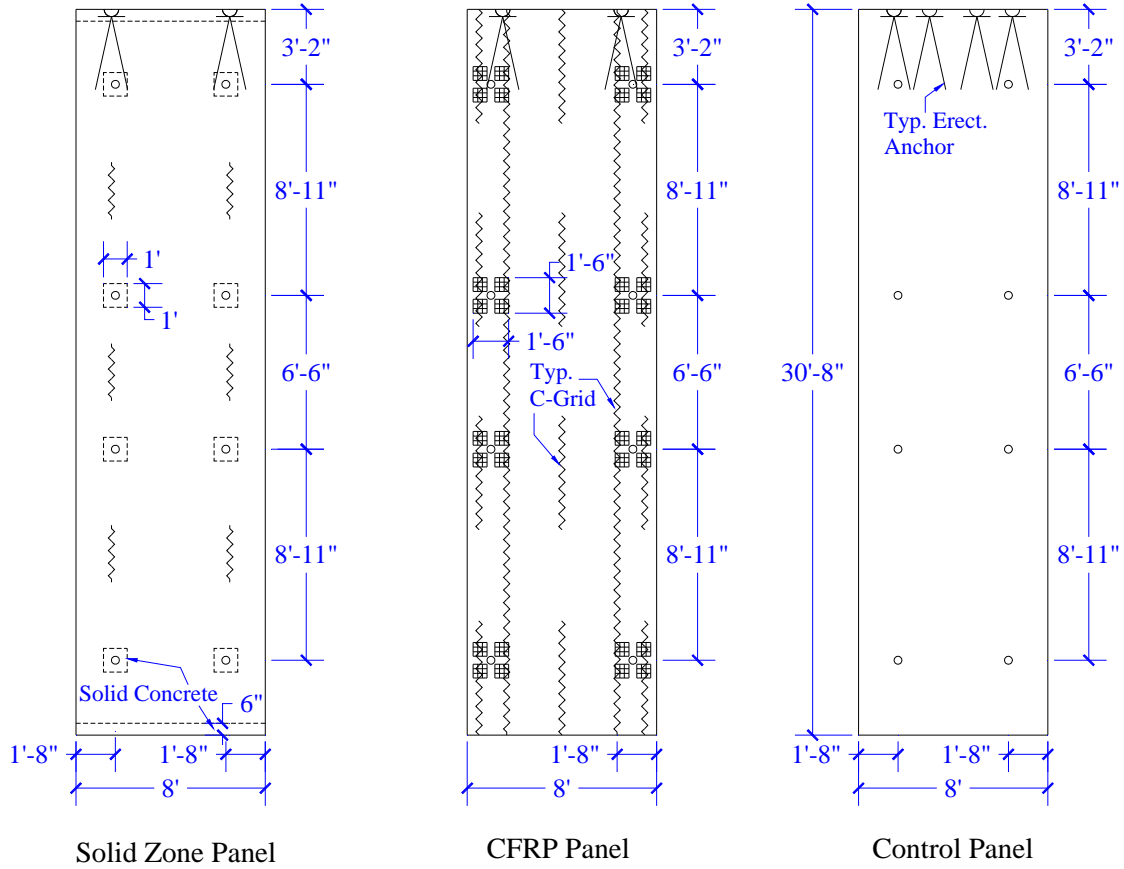

Figure 1: Wall Elevations

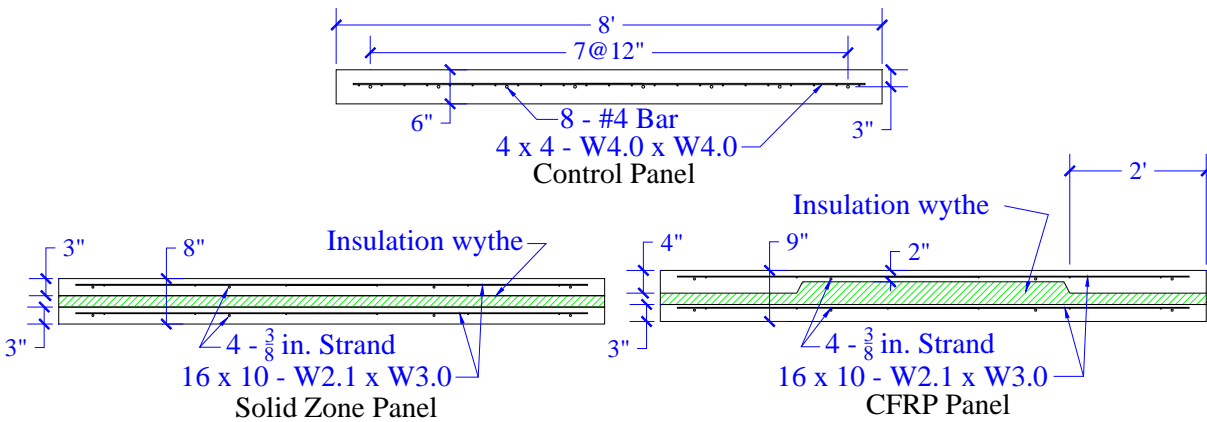

Figure 2: Wall Sections

All of the panels were designed for the same 110 mph, exposure C wind loads in addition to the stripping and handling load conditions.

3.1. Solid Zone Wall Panel

The solid zone panel contained solid zones of concrete connecting the exterior and interior wythes at eight locations on the face of the panel and at each end. The solid zones at each end extended the full width of panel. The panel is insulated with expanded polystyrene insulation (aka. Bead-board) between the wythes. The solid zones were present to provide a shear transfer mechanism between the exterior and interior wythe so that composite action could occur. To provide additional continuity between solid zones C-grid® ties were also used as illustrated in Figure 1 and seen in Figure 3. The proprietary C-grid® CFRP reinforcement is produced by Carbon Cast. The panels were designed to provide 80% composite action. The presence of the solid zones reduces the thermal insulation properties of the wall panel by producing a thermal bridge between the interior and exterior wythe of the panel.

The panel has an overall depth of 8 in. and is referred to as a 3-2-3 panel due to the 3 in. structural wythe, 2 in. insulation, and 3 in. architectural wythe. The panel is prestressed with 8 – 3/8 in. diameter grade 270 low relaxation seven wire strands. Four strands were located in the center of each wythe making them symmetric about the centroid of the section. The strands were subjected to an initial jacking force of 70% of ultimate or 16.1 kips (71.6 kN) each. In addition Welded Wire Reinforcement (WWR) is used in each wythe to meet temperature and shrinkage reinforcement requirements.

3.2. CFRP Wall Panel

The section has an overall depth of 9 in. and consists of a 4 in. structural wythe, 2 in. of insulation, and a 3 in. architectural wythe. The structural wythe has a non-uniform section with larger 4 in. sections on side edges and a reduced 2 in. thickness in the middle. The larger 4 in. portion is used to anchor embedded connectors for stripping and handling. The panel has WWR in each wythe for temperature and shrinkage demands. C-grid® CFRP reinforcement is used to connect the interior and exterior wythes. Since the CFRP sandwich panel does not have a solid concrete bridge between the interior and exterior wythe the CFRP panel has enhanced thermal properties over the solid zone system (see Figure 1 and Figure 2). A picture of C-Grid® is illustrated in Figure 3.



Figure 3: C-grid® wythe connection after testing (note section is damaged in photo due to loading)

The panel is prestressed with 8 – 3/8 in. diameter grade 270 low relaxation seven wire strands. Four strands were located 2 in. from the outside face of the architectural wythe and 4 strands were located 1.5 in. from the inside face of the structural wythe. The strands were subjected to an initial jacking force of 70% of ultimate or 16.1 kips (71.6 kN) each.

3.3. Control Wall Panel

The third panel consists of a 6 in. thick reinforced concrete panel. The panel is designed to have the same mass as the other two systems and designed for the same loads. The panel is conventionally reinforced with 8 #4 grade 60 bars running continuously top to bottom at the centroid of the section. In addition WWR is used to meet temperature and shrinkage reinforcement requirements in the horizontal direction. The solid control panel does not represent typical construction but serves as a research only comparison for the conventional precast prestressed panels. The ultimate flexural strength of the panel is significantly less than the sandwich panels.

3.4. Material Properties

The 28-day concrete compressive strength for the panels were 8.90 ksi (61.4 MPa), 8.60 ksi (59.3 MPa), and 7.56 ksi (52.1 MPa) for the Solid Zone, Carbon Fiber Panel, and Control, respectively. It is assumed that the No.4 bar met ASTM A706 specifications⁷ and the WWR met ASTM A185 specifications⁸. The prestressing strands were 270 ksi (1862 MPa) low relaxation 3/8 in. (9.5 mm) diameter seven wire strands meeting ASTM A416 specifications.

4. Experimental Setup

The panels were subjected to a bare explosive event at Tyndall Air Force Base in Florida. The test panels were installed in a reaction structure. The reaction structure consists of a heavily reinforced precast reaction system which supports the panels at the top and bottom of the walls. The sides of the walls are given a $\frac{1}{4}$ in. gap on either side to allow for unrestrained movement and a one way action response. Based on the connection details used (Figure 4) the assumption is made that the panels are simply supported; with the pin support at the base and the roller support at the top end. The supports create a clear span of 30 ft between floor and ceiling.

The gaps on the sides of the walls were covered with metal flashing to limit pressure from entering the inside of the reaction structure. The walls represent non-load bearing wall panels, thus additional gravity loads are not applied. A schematic of the reaction structure is shown in Figure 4 and a photo is shown in Figure 5b.

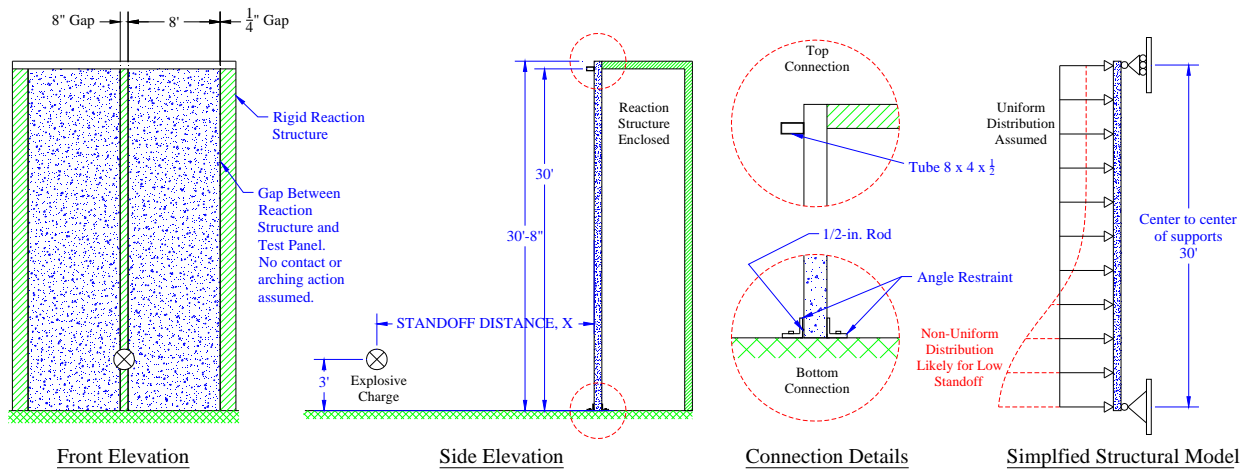
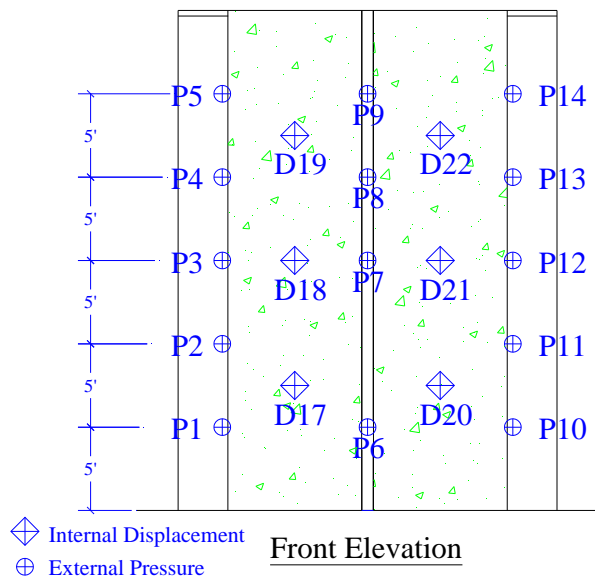

Figure 4: Loading configuration

4.1. Instrumentation

The instrumentation consisted of 14 external pressure gages distributed around the face of the test structure, 2 internal pressure gages located on the rear wall of each chamber, and 6 displacement gages attached to the interior face of the walls. The internal pressure gages were located at approximately 6 ft off the ground and were oriented vertically to measure the pressure increase within the building. The location of the instrumentation on the panels and reaction structure is illustrated in Figure 5.



a) Instrumentation layout



b) Metroframe

Figure 5: Instrumentation layout

4.1.1 Displacement and Pressure

The dynamic pressure histories were recorded with Kulite XT-190 pressure gages. The displacement gages are composed of 50 in. stroke custom potentiometers designed to produce accurate measurements at high rates. A special direct drive fixture is used to eliminate any time lag on the reading or virtual inertial displacements. Displacement gages were used to record panel deflections at the span quarter points. The pressure and displacement gages are shown installed on the fixture in Figure 6.

Displacement and pressure data is recorded on a Hi Techniques data acquisition operating with Win600 software. The system acquires data at 2 million samples per second. In most cases, data is recorded until motion of the panels drop to zero. This typically occurs within 2 to 3 seconds from the time of detonation.

4.1.2 Video

High speed video was recorded to capture the response on the inside and outside of the reaction structure. The external video was recorded using a Phantom 7.1 camera while the internal was recorded using Phantom 4.3 camera. All high-speed cameras recorded at a rate of 1500 frames per second or better depending on light conditions. Video was acquired for four of the five experiments.



a) Displacement gage



b) Pressure gage

Figure 6: Reaction structure prior to detonation

5. Blast Demands

Five levels of increasing pressure demand were applied. The pressures are generated by detonation of high explosives at a stand-off from the wall. Explosive charges were placed perpendicular to the face of the wall panels and aligned with a point midway between the panels. The blast demands and tested components are summarized in Table 1.

Table 1: Test matrix and applied blast demands						
Experiment	Panel 1	Panel 2	Charge Size [lbs of ANFO]	Standoff Distance [ft]	Peak Positive Pressure [psi]	Peak Impulse* [psi-msec]
1	Solid Zone Panel 1	Control Panel 1				
2	Solid Zone Panel 1	Control Panel 1				
3	CFRP Panel 1	Control Panel 2				
4	CFRP Panel 1	Control Panel 2				
5	CFRP Panel 1	Control Panel 2				

*Measured at pressure gage P7, ** Measured at pressure gage P6

REMOVED

Figure 7: Measured reflected pressure demands for each experiment

The five pressure time histories measured on the walls are presented in Figure 7. The first and second experiments were conducted on control wall 1 and the solid zone panel. The third, fourth, and fifth experiments involved control panel 2 and the CFRP panel. No repair was made to the walls between subsequent load applications. In some cases the walls exhibited considerable permanent deformation from the previous load cycle. In most cases this deformation is accounted for in the data presented.

5.1. Experiment 1 – Control 1 vs. Solid Zone 1

The first experiment resulted in no visible cracking or damage thus the panels were loaded with a subsequent charge at a reduced standoff. The peak positive pressures recorded at each pressure gage, the maximum positive impulse and the maximum displacements measured at each displacement gage are tabulated in Table 2.

Table 2: Max pressure, impulse, and displacements Experiment 1 [psi, psi-ms, in.]						
Charge REMOVED			Standoff REMOVED			
Pressure	P5		P9		P14	
	P4		P8		P13	
	P3		P7		P12	
	P2					
	P1		P6		P10	
	P-internal 1		P-internal 2		Free Field	
Impulse	I5		I9		I14	
	I4		I8		I13	
	I3		I7		I12	
	I2					
	I1		I6		I10	
Displacement	D17	1.24	D18	1.74	D19	1.08
	D20	1.25	D21	2.24	D22	1.39

The displacement-time history for experiment 1 was measured on both panels. The solid zone panel response is presented in Figure 8 and the control panel response is presented in Figure 9.

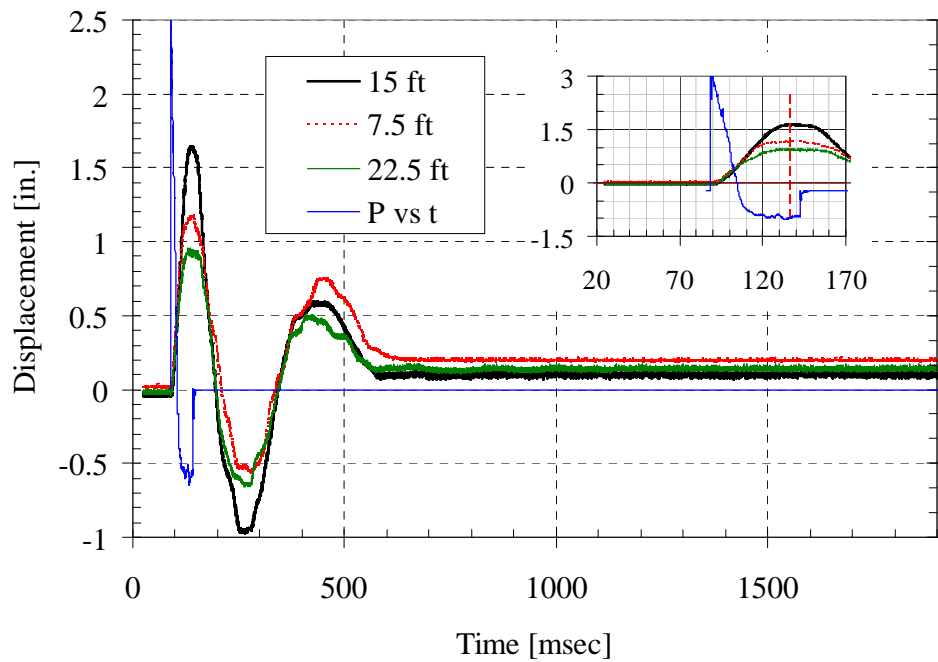

Figure 8: Measured reflected pressure and deflections for Experiment 1 Solid Zone Panel

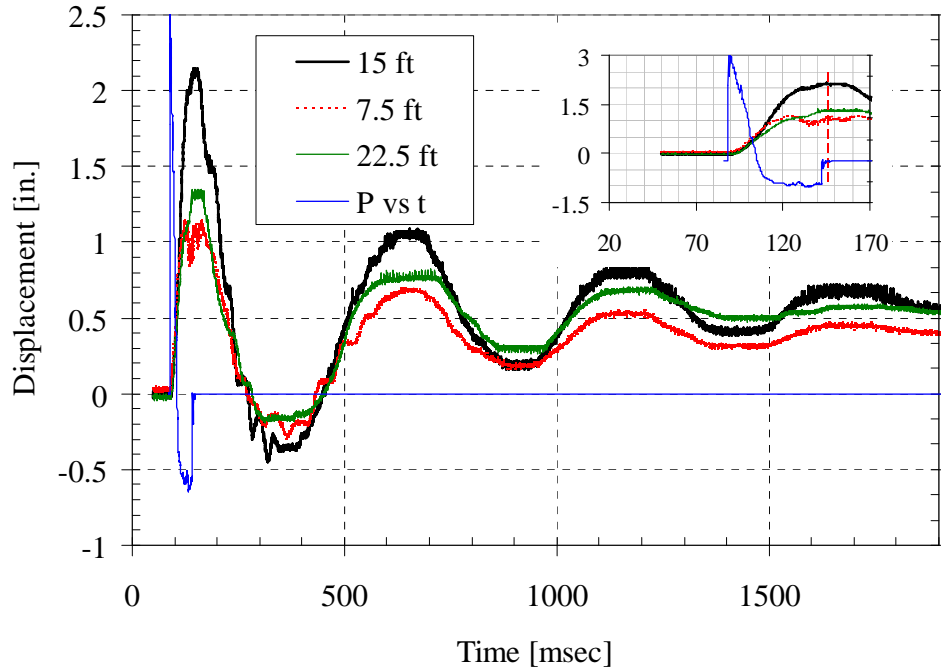

Figure 9: Measured reflected pressure and deflections for Experiment 1 Control Panel

The harmonic deformation response continued for more than three cycles. The control panel had approximately 0.5 in. of permanent inward deformation.

5.2. Experiment 2 – Control 1 vs. Solid Zone 1

The second experiment resulted in distributed flexural cracking in the control panel and a few primary cracks on the sandwich panel. The peak positive pressures recorded at each pressure gage, the maximum positive impulse and the maximum displacements measured at each displacement gage are tabulated in Table 3.

Table 3: Max pressure, impulse, and displacements Experiment 2 [psi, psi-ms, in.]						
Charge REMOVED			Standoff REMOVED			
Pressure	P5		P9		P14	
	P4		P8		P13	
	P3		P7		P12	
	P2				P11	
	P1		P6		P10	
	P-internal 1		P-internal 2		Free Field	
Impulse	I5		I9		I14	
	I4		I8		I13	
	I3		I7		I12	
	I2				I11	
	I1		I6		I10	
Displacement	D17	1.931	D18	2.856	D19	1.951
	D20	1.585	D21	3.637	D22	2.086

The displacement-time history for experiment 2 was measured on both panels. The solid zone panel response is presented in Figure 10 and the control panel response is presented in Figure 11. Both panels had permanent internal deformation.

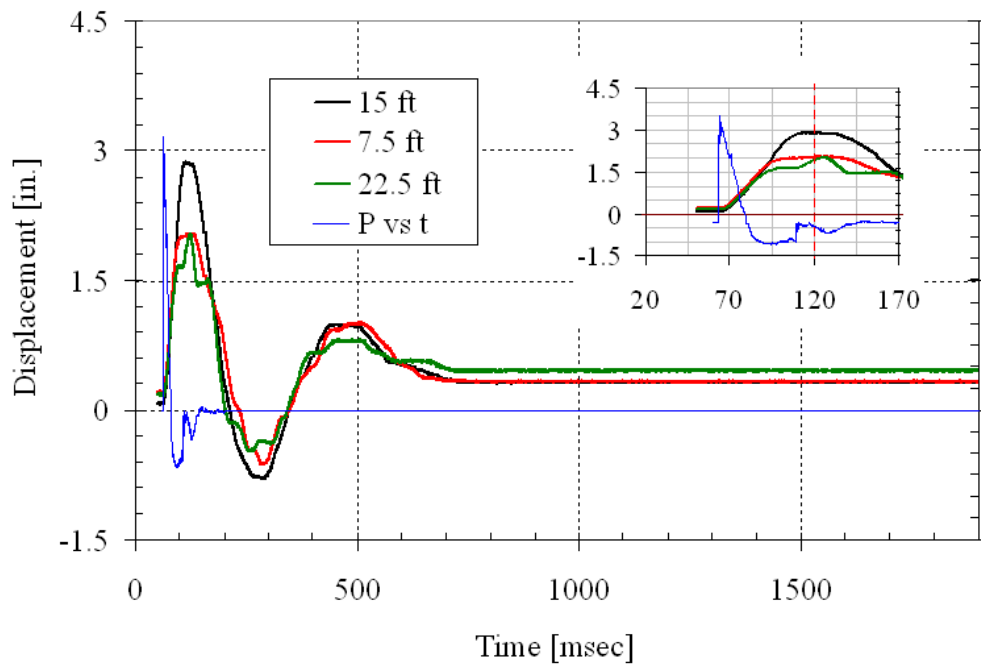

Figure 10: Measured reflected pressure and deflections for Experiment 2 Solid Zone Panel 1

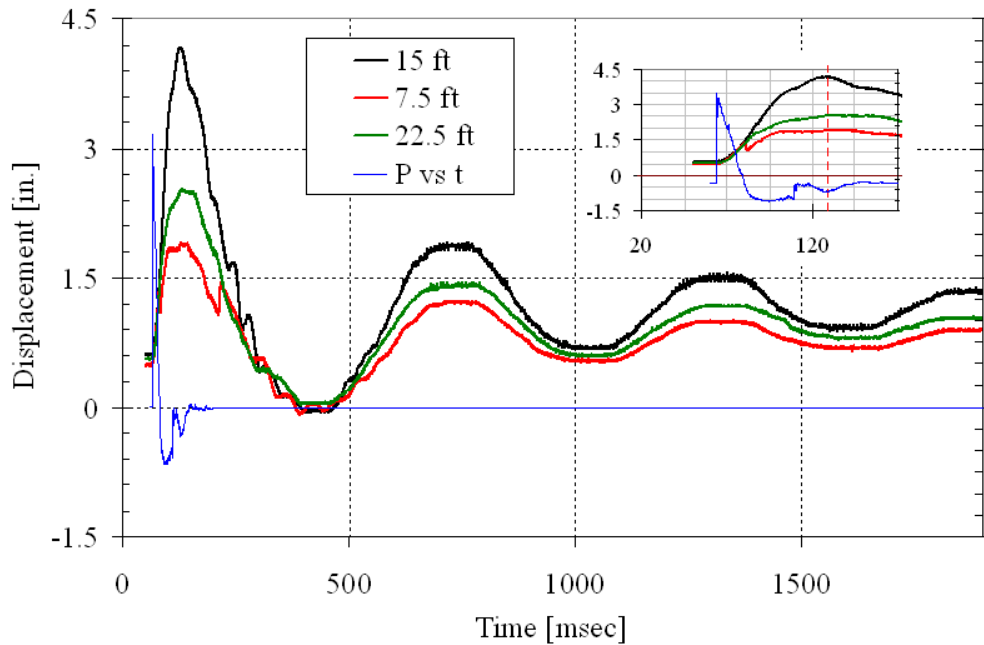

Figure 11: Measured reflected pressure and deformation response of Experiment 2 Control Panel 1

The wall panels were removed for inspection following the second detonation (Figure 12). The crack locations were noted and are illustrated in Figure 13 for the control panel and Figure 14 for the solid zone panel. As can be observed from the images, the cracks were flexural in nature. In the control panel the cracks propagated through approximately half the depth. The flexural cracking in the solid zone panel occurred only on the inside face of the panel. The absence of cracking on the face of the solid zone panel is indicative of fully composite action. Under partial composite action both the interior and exterior wythes would flex independently. This would result in small flexural cracks on both panels as opposed to the cracking observed.



Figure 12: Post test condition of panels

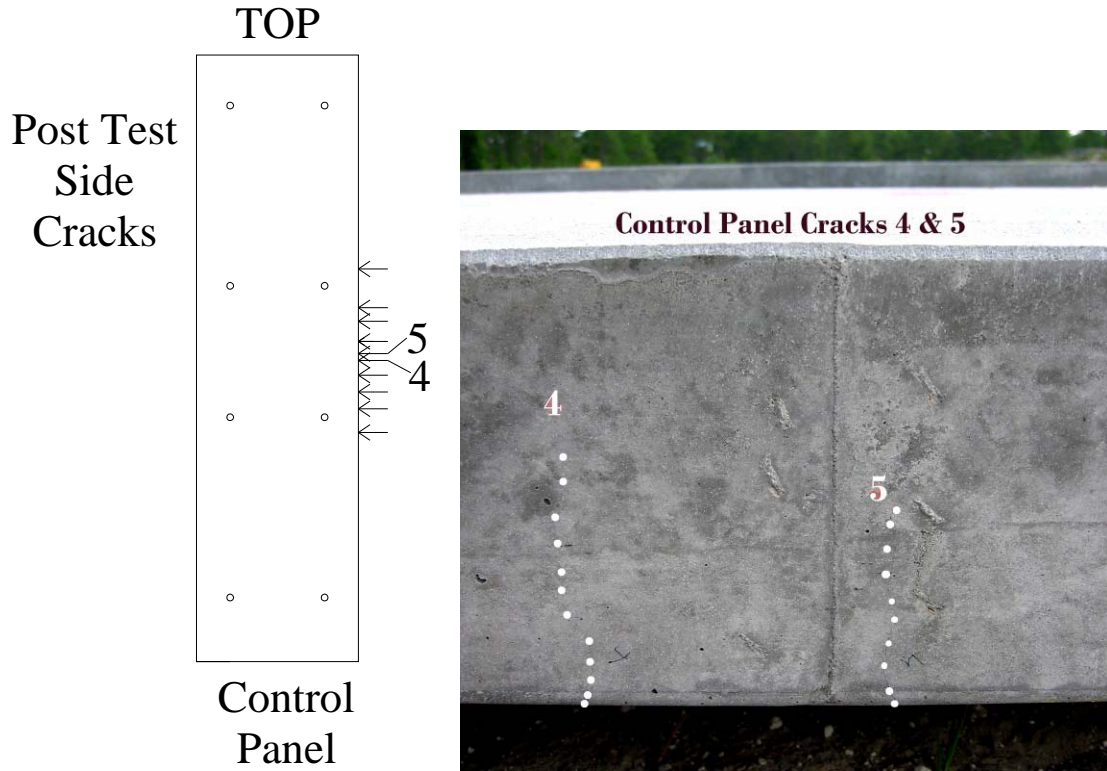
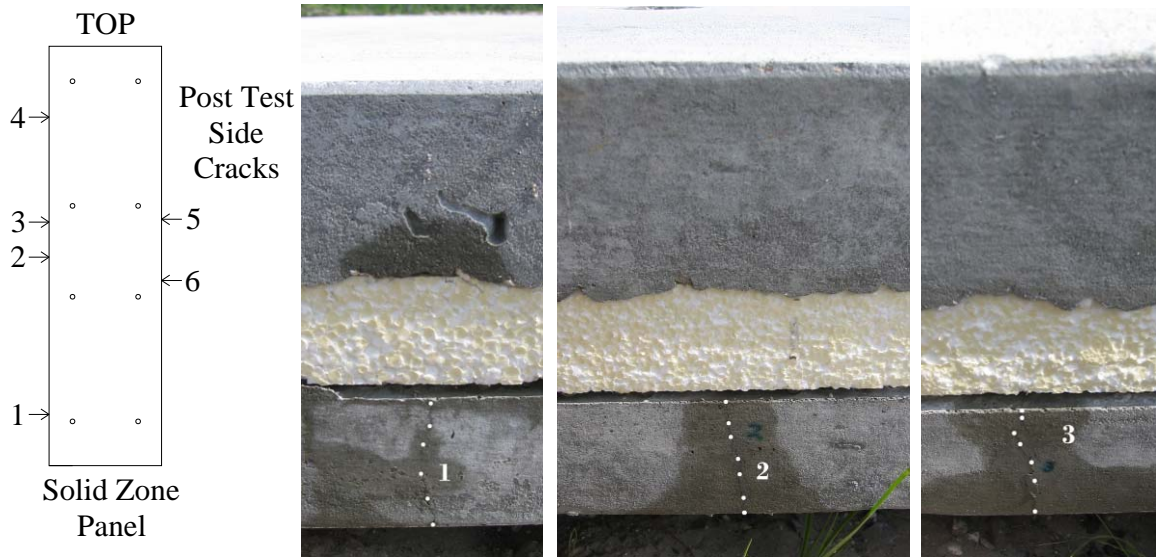

Figure 13: Flexural crack location on control panel and side of panel



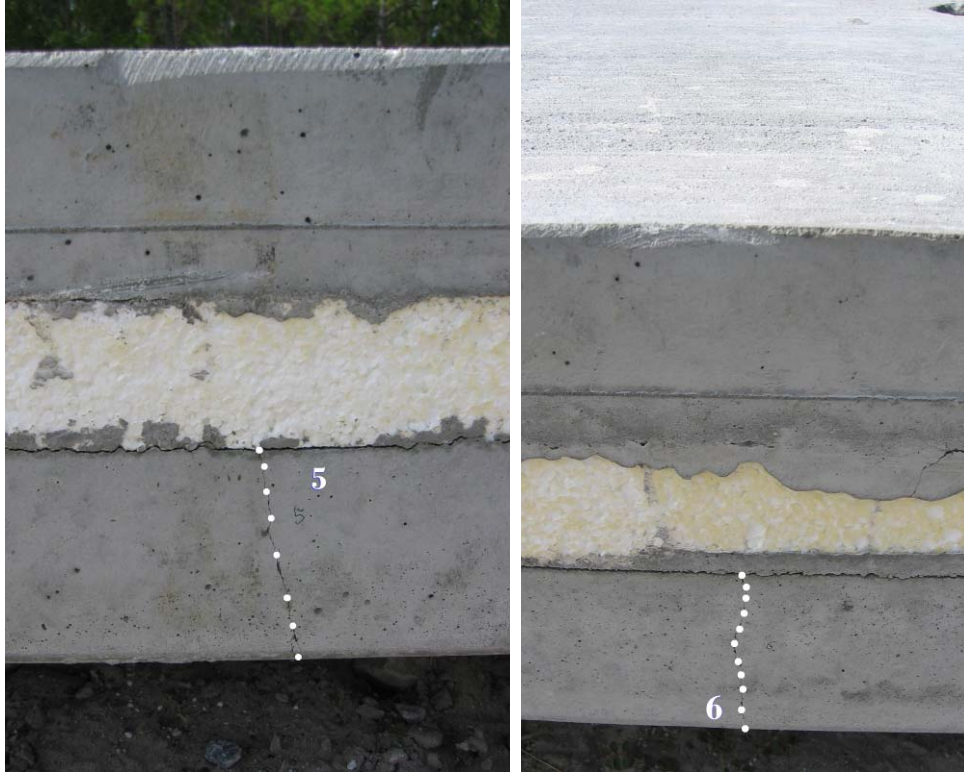

Figure 14: Flexural crack locations on solid zone panel

5.3. Experiment 3 – Control 2 vs. CFRP 1

For the third experiment new wall panels were installed in the reaction structure. A CFRP panel was installed in the left opening and a control panel in the right opening. The peak positive pressures recorded at each pressure gage, the maximum positive impulse and the maximum displacements measured at each displacement gage are tabulated in Table 4.

Table 4: Max pressure, impulse, and displacements Experiment 3 [psi, psi-ms, in.]						
Charge REMOVED				Standoff REMOVED		
Pressure	P5		P9		P14	
	P4		P8		P13	
	P3		P7		P12	
	P2				P11	
	P1		P6		P10	
	P-internal 1		P-internal 2		Free Field	
Impulse	I5		I9		I14	
	I4		I8		I13	
	I3		I7		I12	
	I2				I11	
	I1		I6		I10	
Displacement	D17	2.979/-0.513	D18	4.615/-0.597	D19	2.699/-0.553
	D20	2.465/NA	D21	5.489/NA	D22	3.640/NA

The CFRP panel response is presented in Figure 15 and the control panel response is presented in Figure 16. Both panels exhibited a permanent inward deflection with the control panel exhibiting approximately twice that of the CFRP panel.

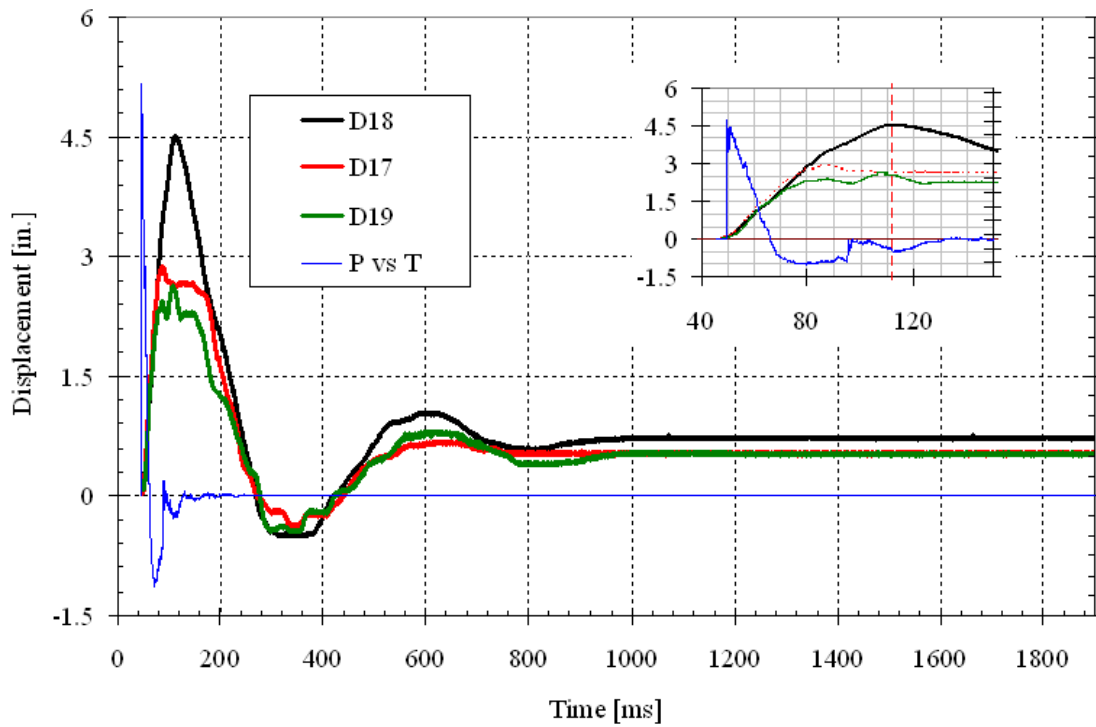

Figure 15: Measured reflected pressure and deflections for Experiment 3 CFRP Panel 1

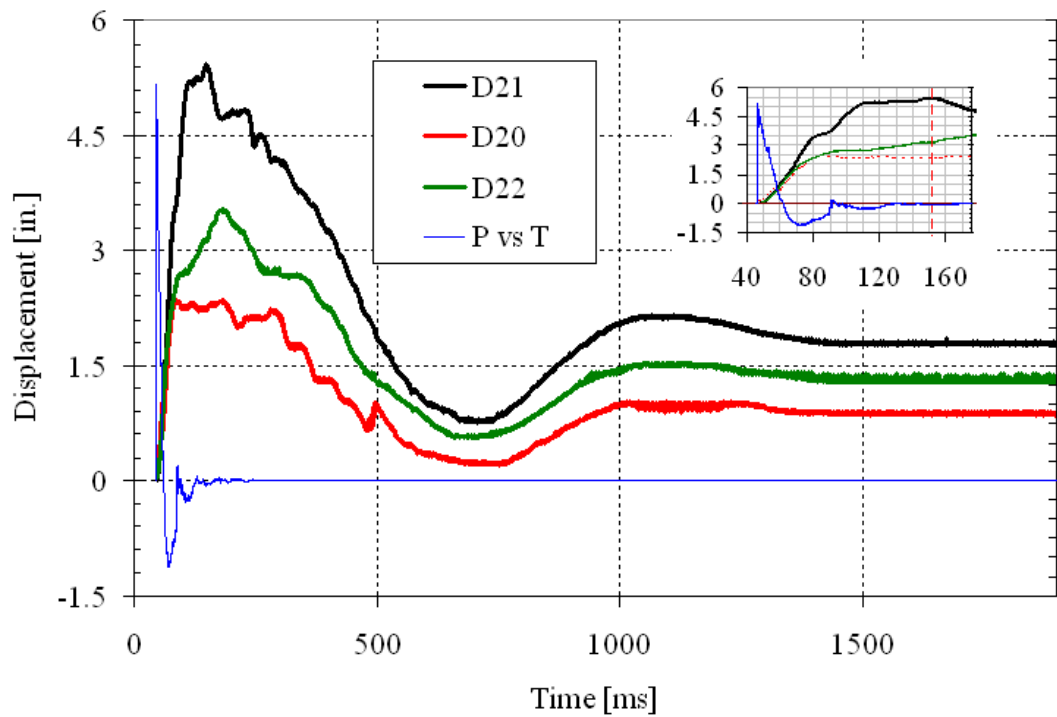

Figure 16: Measured reflected pressure and deflections for Experiment 3 Control Panel 2

The cracking pattern on the interior face of the panel was recorded after the experiment (Figure 17). The cracks were clearly visible on the inside face indicative of flexural cracking. Cracking is more extensive for the control panel as compared to the sandwich panel. The crack size was largest at the mid-height and decreased toward the supports in accordance with one-way action behavior. The non-prestressed control panel exhibited distributed cracking over the length of the panel with the majority of damage occurring over the middle 9.5 ft of the panel. This corresponds to a plastic region equal to approximately 19 times the depth of the panel. The CFRP panel exhibited discrete cracking at the supports and at mid height. The minimal number of cracks at mid-height is indicative of a centralized plastic hinge region of approximately 18in. A vertical crack, however, was observed in the CFRP panel. This is indicative of two-way action at the bottom of the panel and may be due to binding between the panel and reaction structure. There was no obvious separation between the wythes for the CFRP panel. A permanent deformation of less than 3 in. (76 mm) over the 30 ft (9.1 m) span was measured.

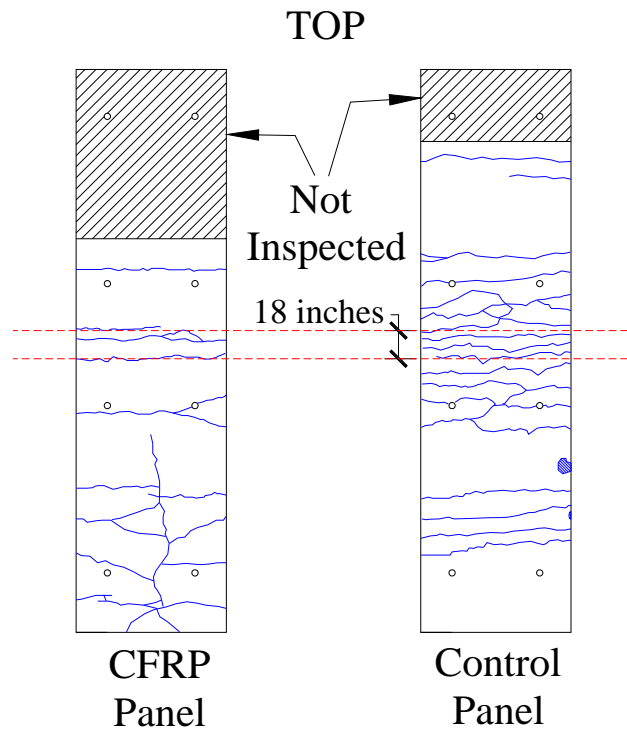

Figure 17: Measured cracking on inside face of panels post-test 3

5.4. Experiment 4 – Control 2 vs. CFRP 1

The fourth experiment resulted in additional flexural cracking in the control panel and few more primary cracks on the sandwich panel. The peak positive pressures recorded at each pressure gage, the maximum positive impulse and the maximum displacements measured at each displacement gage are tabulated in Table 5.

Table 5: Max pressure, impulse, and displacements Experiment 4 [psi, psi-ms, in.]						
Charge REMOVED			Standoff REMOVED			
Pressure	P5	Not recorded	P9	Not recorded	P14	Not recorded
	P4	Not recorded	P8	Not recorded	P13	Not recorded
	P3	Not recorded	P7	Not recorded	P12	Not recorded
	P2	Not recorded			P11	Not recorded
	P1*		P6*		P10*	
Impulse	I1		I6		I10	
Displ.	D17**	3.830/-0.840	D18**	6.211/-1.173	D19**	3.208/-0.867
	D20**	4.604/-1.216	D21**	7.002/-1.797	D22**	4.531/-1.032

* Pressure data went out of range of gage. ** Does not include initial offset

The CFRP panel response is presented in Figure 18 and the control panel response is presented in Figure 19.

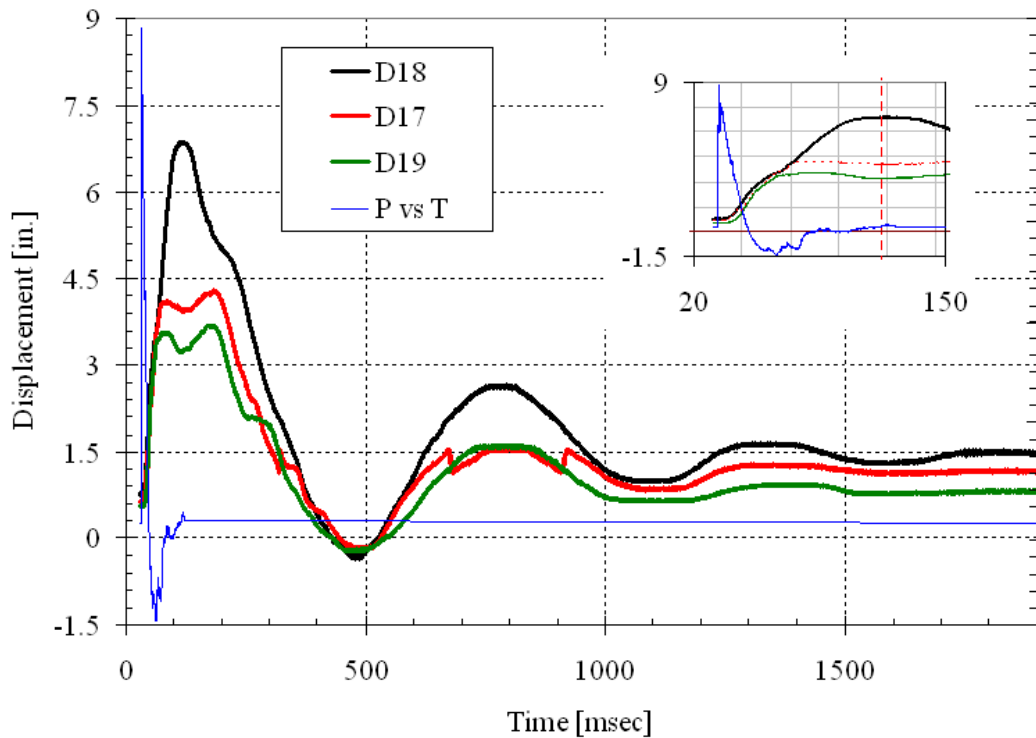

Figure 18: Measured reflected pressure and deflections for Experiment 4 CFRP Panel 1

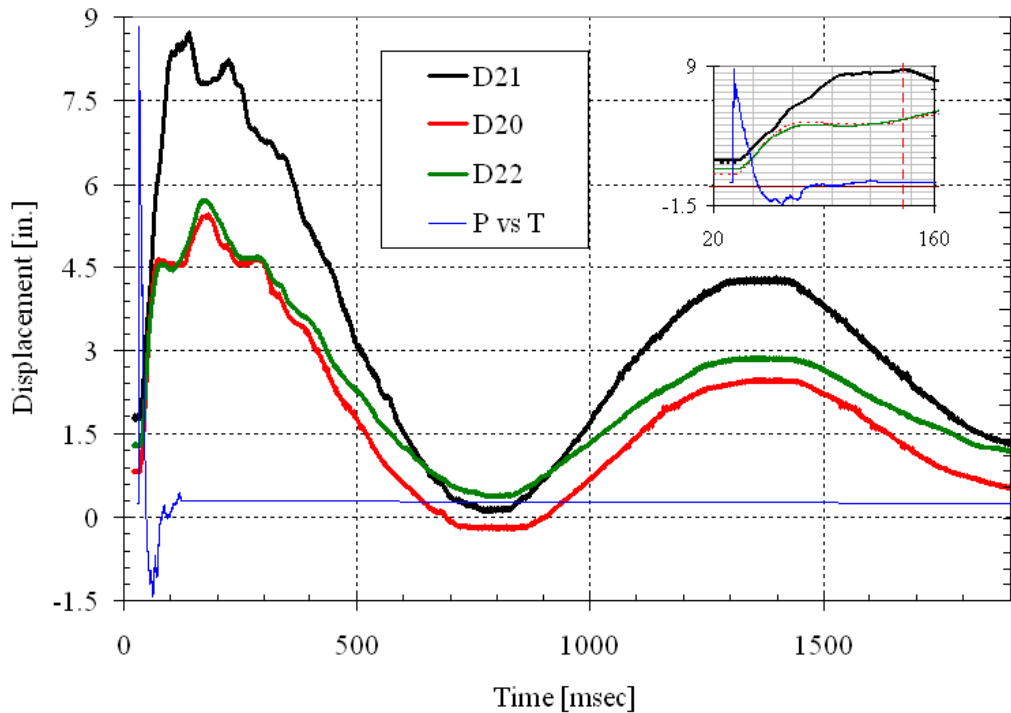

Figure 19: Measured reflected pressure and deflections for Experiment 4 Control Panel 2

The wall panels reached their peak positive deformation during their free vibration. The deformation at the mid height (D18, D21) is plotted along with the deformations at the quarter points (D17, D19, D20, D22). The deformation is largest at the mid-height and comparable at the quarter points. The lower deformation is marginally higher since the detonation occurs at ground level and applies a higher demand to the lower quarter point.

The control panel exhibits a larger deformation than the CFRP panel for the same demands. This is attributed to the difference in the flexural resistance between the two panels. The sandwich panel has 3 in. more overall depth than the control panel as well as two layers of reinforcement. This provides a larger moment arm between the compression zone and the tensile steel thus increasing the resistance.

5.5. Experiment 5 – Control 2 vs. CFRP 1

The fifth experiment resulted in a higher concentration of distributed flexural cracks in the control panel and many more primary cracks on the sandwich panel. The peak positive pressures recorded at each pressure gage, the maximum positive impulse and the maximum displacements measured at each displacement gage are tabulated in Table 6.

Table 6: Max pressure, impulse, and displacements* Experiment 5 [psi, psi-ms, in.]						
Charge REMOVED			Standoff REMOVED			
Pressure	P5		P9		P14	
	P4		P8		P13	
	P3		P7		P12	
	P2				P11	
	P1		P6		P10	
	P-internal 1		P-internal 2		Free Field	
Impulse	I5		I9		I14	
	I4		I8		I13	
	I3		I7		I12	
	I2				I11	
	I1		I6		I10	
Displacement	D17	13.467	D18	15.474	D19	9.525
	D20	13.411	D21	17.729	D22	10.845
*Displacements do not included initial offset						

The CFRP panel response is presented in Figure 20 and the control panel response is presented in Figure 21.

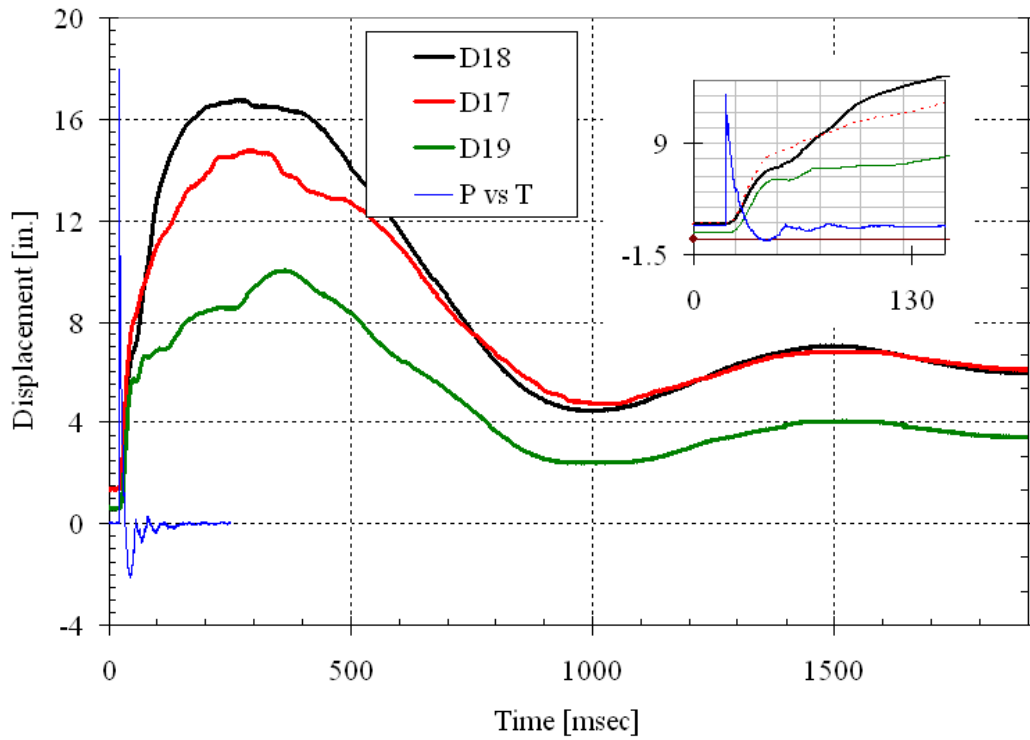

Figure 20: Measured reflected pressure and deflections for Experiment 5 CFRP Panel 1

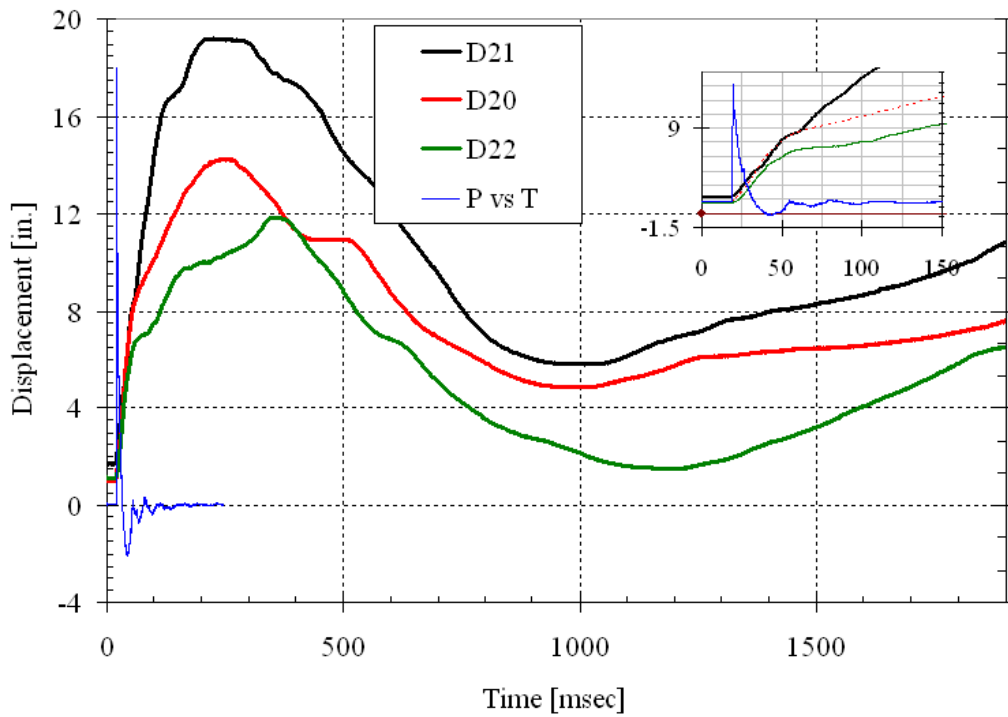

Figure 21: Measured reflected pressure and deflections for Experiment 5 Control Panel 2

The displaced shape of the panel was measured prior to the test and following the tests. The shape over the height of the CFRP and Control walls are presented in Figure 22 and Figure 23. Deflections at the maximum and start points were measured at heights of 7.5 ft, 15 ft and 22.5 ft during the blast response. Other values input based on judgment and the starting shape.

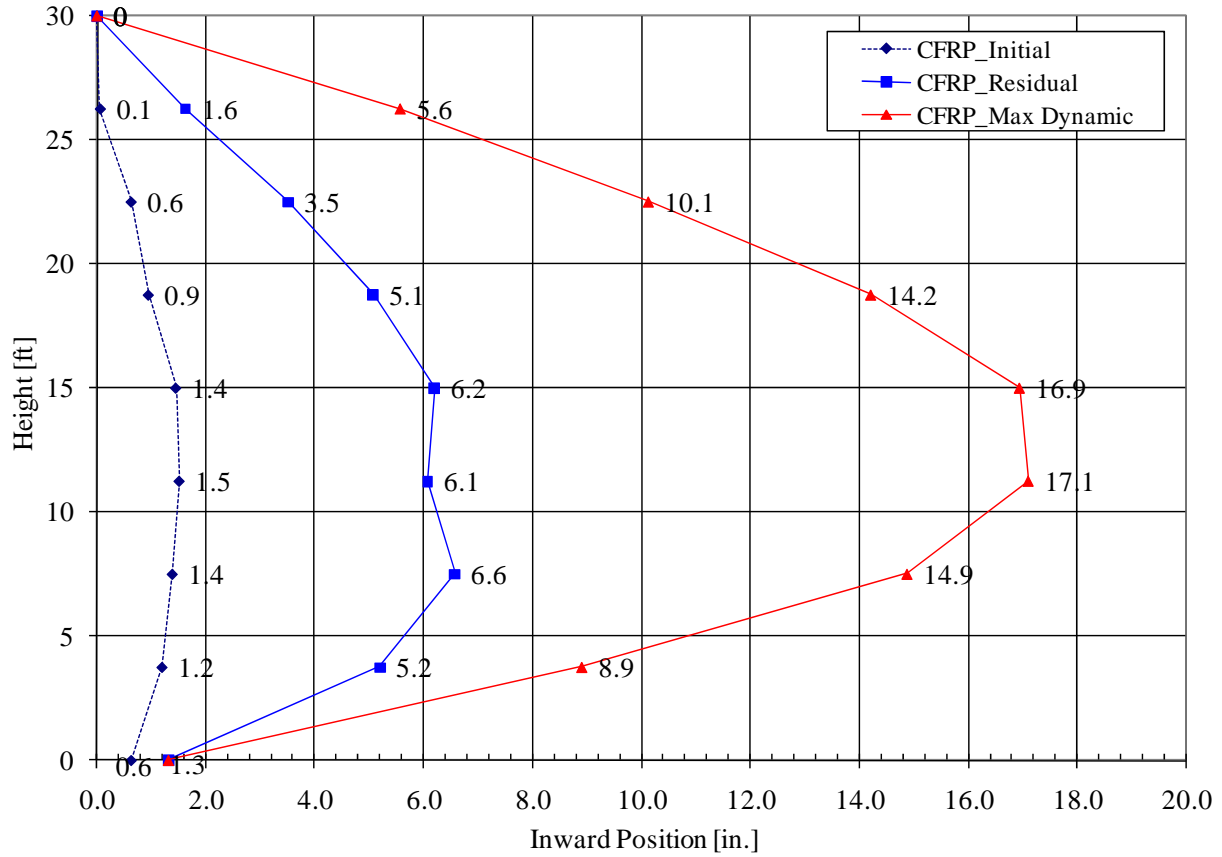

Figure 22: CFRP wall deformed shape before, during and after Experiment 5

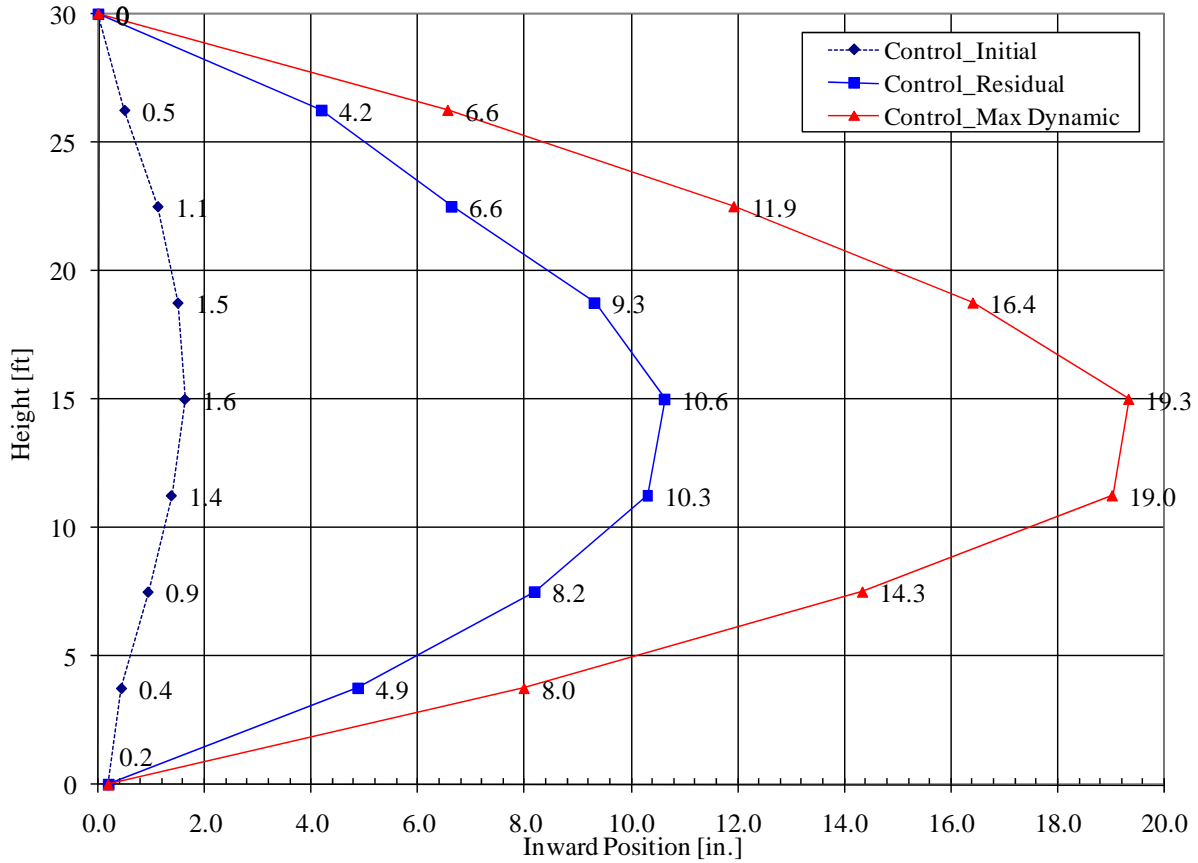

Figure 23: Control wall deformed shape before, during and after Experiment 5

The walls experienced deflections 2 to 3 times the wall thickness or a span-to-deflection ratio close to 20 but remained standing. The last detonation failed the CFRP C-grid® that connected the interior and exterior wythes. The failure occurred over a large portion of the panel; however, the panel did not collapse. A permanent inward deflection at mid-height of approximately 7 in. (Span/50) was measured on the CFRP sandwich wall panel. The permanent deflection and cracking of the panels is clearly observable on photos taken of the wall panels after the detonation as shown in Figure 24, Figure 25, and Figure 26.



Figure 24: External View of Panels after Experiment 5



Figure 25: Internal View of Control Panel after Experiment 5



Figure 26: Internal view of CFRP panel after Experiment 5

6. SBEDS Comparison

The Protective Design Center (PDC) of the US Army Corp of Engineers has developed a single degree of freedom analysis package for evaluation of wall systems. The program is titled Single-Degree-of-Freedom Blast Effects Design Spreadsheets or SBEDS. The software is integrated into Microsoft Excel and has been released as Distribution A, approved for public release, distribution unlimited.

The results of the experimental program were compared to that predicted by SBEDS. To provide a direct comparison the reflected pressure - time curve measured from each test is used as input to the SBEDS model. The analyses were conducted assuming that for each test new undamaged walls were examined. The research program conducted multiple explosions on the same walls. The SBEDS analysis package does not account for pre-cracking therefore the analyses should under-predict the deflections.

The assumptions used for the analyses were as follows:

- The unit weight of the concrete is 135 lb/ft³
- The panels are fully composite and the strands are fully bonded.
- The panels are undamaged and uncracked. Note, this assumption is not valid for experiments 2, 4 and 5.
- The sandwich panels will crack through the interior wythe resulting in a compression zone in the exterior wythe.

The three walls were evaluated using SBEDS: the control wall, the CFRP sandwich wall, and the solid zone sandwich wall panel. The material strengths of the models conformed to the measured properties presented earlier. The measured and predicted displacement time history for the control, CFRP and solid zone panels are presented in Figure 27, Figure 28, and Figure 29.

SBEDS provides an order of magnitude estimate of response for the control panel, CFRP, and solid zone panels subjected to blast pressure loads. The solid reinforced concrete control panel conservatively over-predicts the peak displacement for the 60 ft standoff, but under predicts the peak displacement for all other demands. The SBEDS analyses conservatively over-predict the response for both experiments conducted on the solid zone panel. The SBEDS analyses consistently under-predict the response of the CFRP panels.

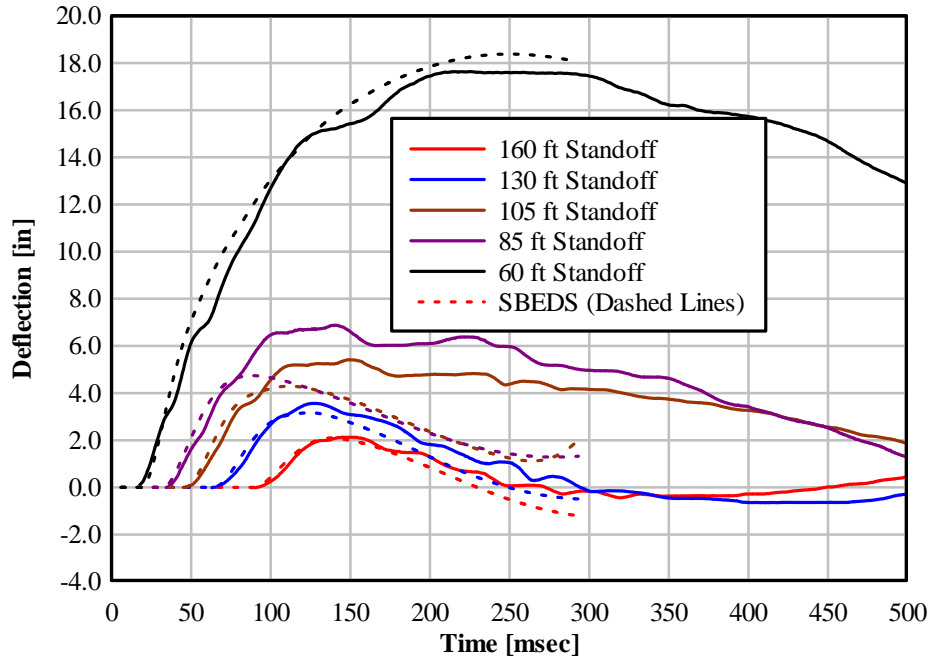

Figure 27: Control wall measured and predicted response

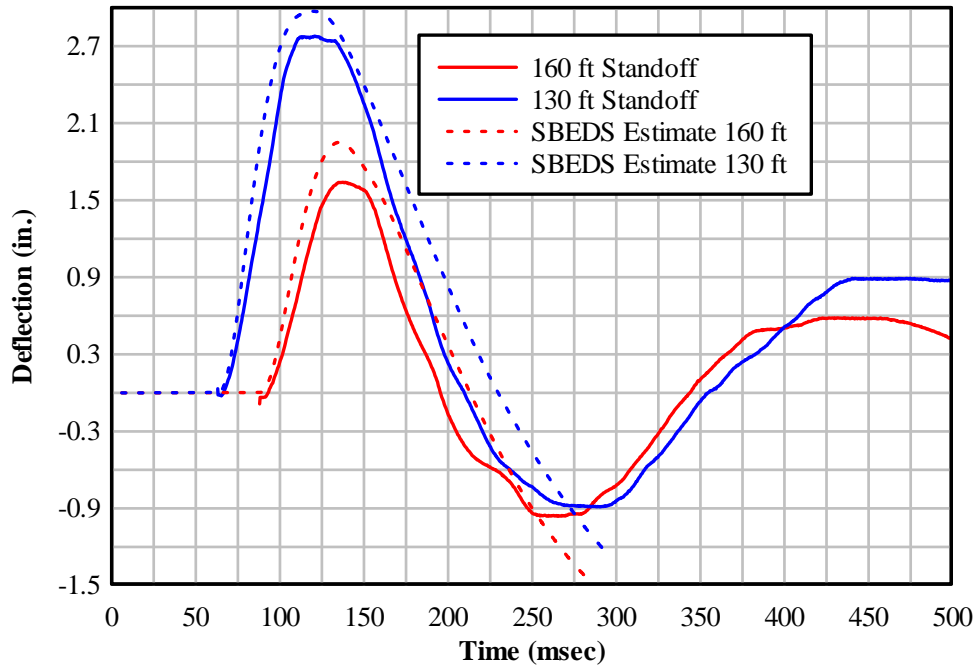

Figure 28: Solid zone wall measured and predicted response

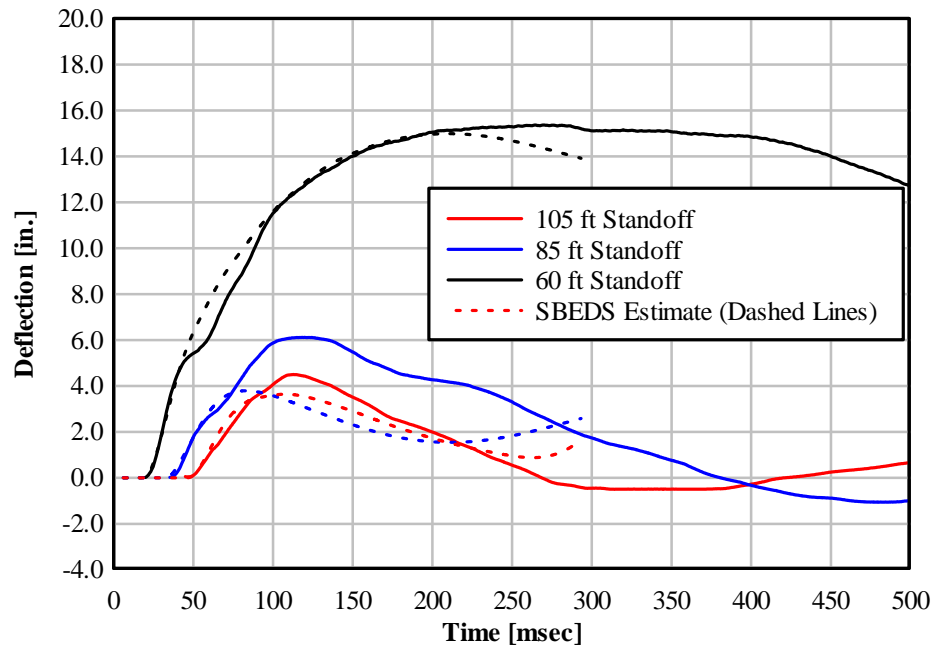

Figure 29: CFRP wall measured and predicted response

7. Summary

Four precast wall panels were examined under five progressively higher explosive demands. The maximum inward deflections for all five experiments are shown in Figure 30 and Figure 31 for the control and sandwich panels respectively. The measured pressure and displacement time histories indicate that the wall panels examined provide a high level of protection.

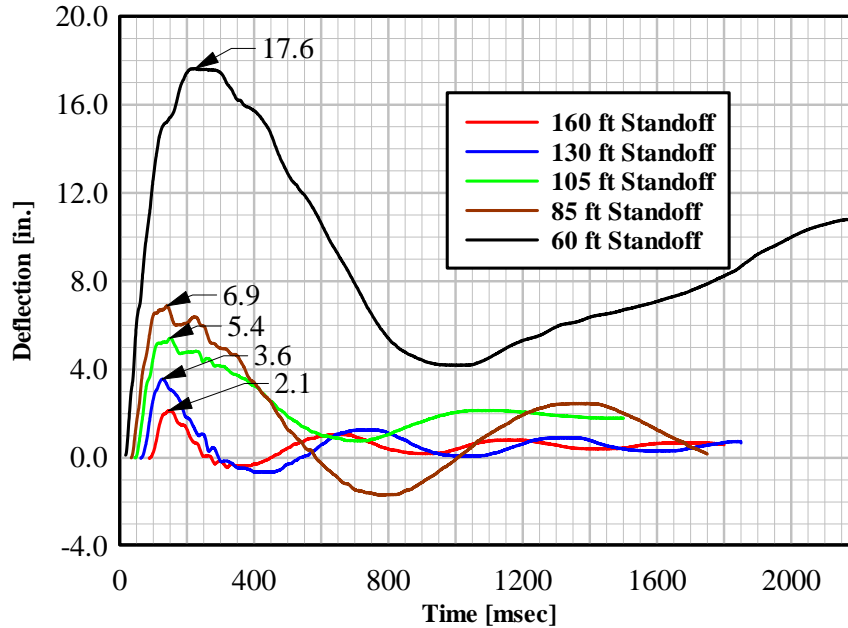

Figure 30: Peak mid-height deflections for control panels XX

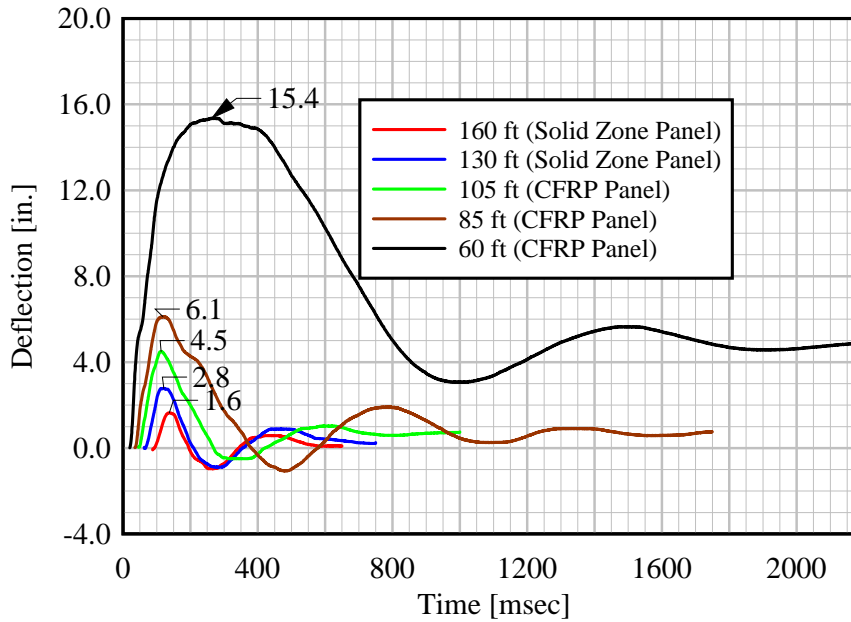

Figure 31: Peak mid-height deflections for sandwich panels XX

The measured responses were modeled using SBEDS and were found to provide an order of magnitude estimate of response for the control panel, CFRP, and solid zone panels subjected to blast pressure loads.

The results of this study have also been used to validate approximate single degree of freedom (SDOF) models. Using these models flexural iso-damage curves were developed for blast assessment of precast concrete elements. The methods used to develop these curves and the accuracy of the methods is presented in the PCI journal paper:

- Cramsey, N., Naito, C., “Analytical Assessment of the Blast Resistance of Precast, Prestressed Concrete Components,” *Journal of the Precast/Prestressed Concrete Institute*, Vol. 52, No. 6, Nov-Dec, 2007, pp. 67-80.

Additional conclusions and modeling recommendations can be found in the preceding reference.